



SiteRack™

Architectural Strength Illumination™

MOONRISE™ SiteRack™

This SiteRack bicycle parking rack features a point source luminaire integrated into its sculptural, 316 stainless steel form. The 2" schedule 40 material and full weld mounting plates provide a robust structure to secure any type of cycle. With illumination for safety and site way-finding, the LED fixture has reliable performance with a 70° optic at nadir. The symmetric output provides a pool of illumination below the rack and reflects across its surfaces.

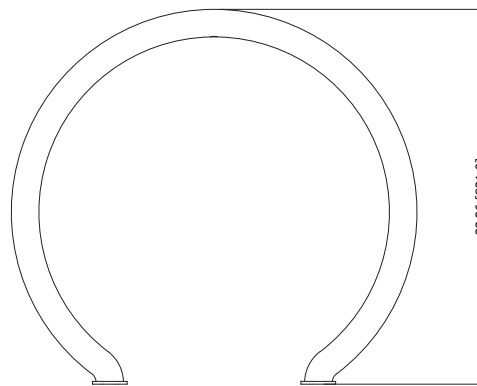

- 2" Schedule 40 stainless steel welded pipe structure
- Solid machined 316 stainless steel LED light engine
- Embed or surface mount options
- 116 lumens per watt LED (500 mA)
- IK10 impact rating and secure installation
- 24VDC operation
- ETL wet location listed
- IP67 ingress protection
- Standard in 2700 K, 3000 K and 4000 K
- Solid color options available

*Specifications subject to change without notice.
Verify data at time of order*

PROJECT NAME: _____

REP AGENCY: _____



SCAN QR CODE
for technical information,
downloads and instructions.



PART NUMBER BUILDER

LTMR40K3SMSB4 <hr style="width: 50%; margin: auto;"/> EXAMPLE	LTMR	COLOR TEMP	DRIVE CURRENT	MOUNTING	SB4
FIXTURE TYPE	30K - 3000 K	5 - 2.2W @ 500 mA	SM - Surface Mount	SB4 - Satin Brush #4	

Solid color LED options are non-standard and may require additional lead-time.

LTMR - SiteRack Moonrise
 27K - 2700 K
 30K - 3000 K
 40K - 4000 K
 BLU - Blue
 GRN - Green
 RED - Red
 AMB - Amber
 3 - 1.7W @ 350 mA
 EB - Embed Mount

ELECTRICAL SPECIFICATIONS

Intertek
 All electrical connections to be made by a qualified electrician in accordance with all national, state and local electrical codes.

24VDC	ETL LISTED WET, IK10, IP67, CE	0-10V INPUT	-40°F TO +120°F	
INPUT VOLTAGE	CERTIFICATIONS	DIMMING	OPERATING TEMP	
CLASS 2 REQUIRED	5 YEARS	UP TO 116 LM/W LED	80+	8"
DRIVER	WARRANTY	EFFICIENCY	CRI	WIRE LENGTH

LIGHT ENGINE CONSTRUCTION

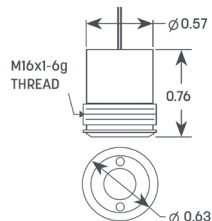

The Lumenpod® 16's threaded stainless steel body dissipates heat directly into the mounting material. A machined shoulder positions it nearly flush with any diameter pipe post, flat or square stock.

PHOTOMETRICS

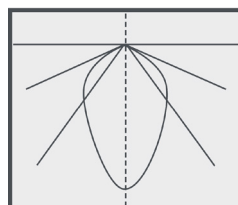

The 70 degree optic provides superb illumination output for this application. An IES report to view or download is available by scanning the QR code or visiting our website.

LUMENGEAR™ LED DRIVER & NEMA ENCLOSURE OPTIONS

Wagner offers multiple ETL listed options for both 24VDC power supplies and NEMA enclosures. Quantities and types will be configured based on your specifications and design. Additional specification options are available by request. Not all options apply to all products. Please verify compatibility with the factory.

CLASS II DRIVERS:

- STD 25W and 100W
- 0-10V Dimming Protocol
- Made in USA Units Available

NEMA ENCLOSURES:

- 4X - Polycarbonate
- 4X - Painted Steel
- 4X - Stainless Steel

Specifications subject to change without notice. Verify data at time of order.

@wagnercompanies

The Moonrise SiteRack is able to be ordered with provisions for either surface or embed mounting. Please specify your mounting type at the time of order. All site preparations, including exterior, burial grade 1/2" electrical conduit, stubbed up 4-6" at each location. Coordination with the qualified installing electrician is imperative throughout the install process. The light, associated components, remote enclosure, power supply, instructions, mounting fasteners and security bit will be shipped with the SiteRack in a separate box.

SURFACE MOUNTING INSTRUCTIONS

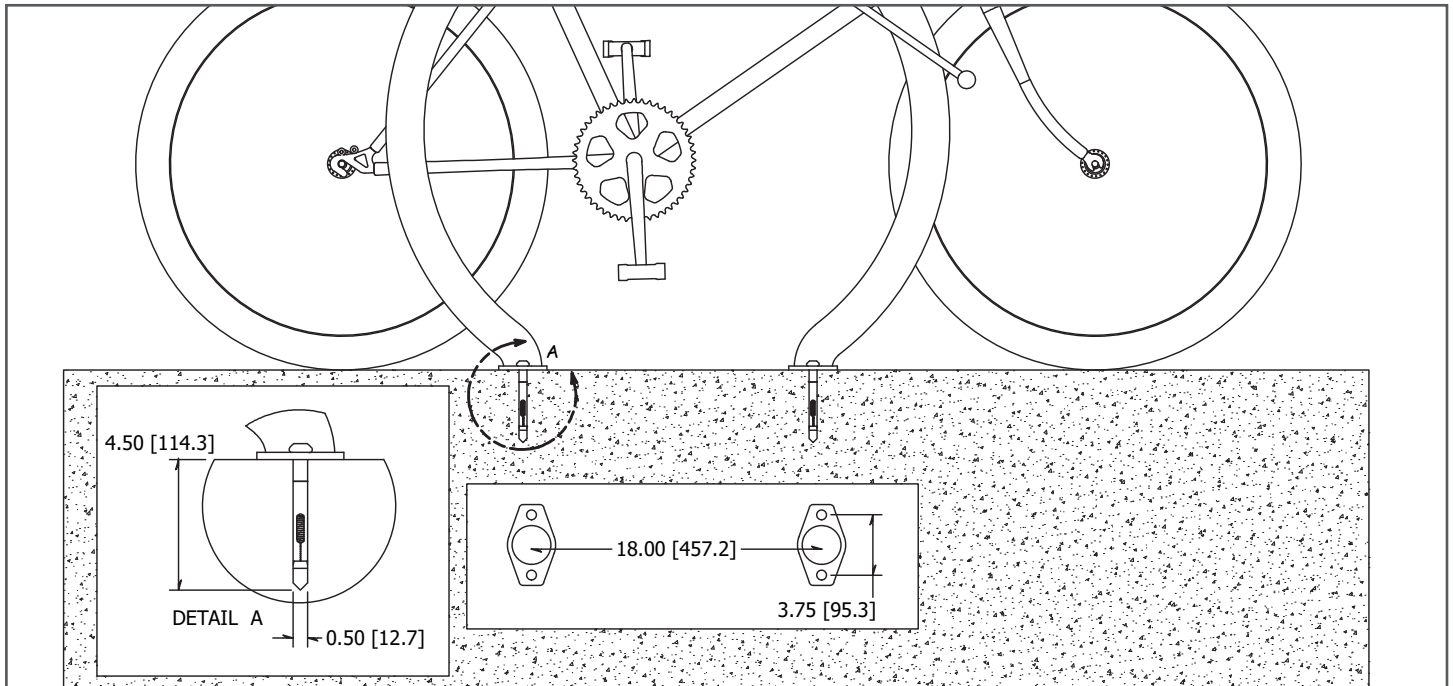

SECURE-BOLT SLEEVE ANCHOR INSTALLATION

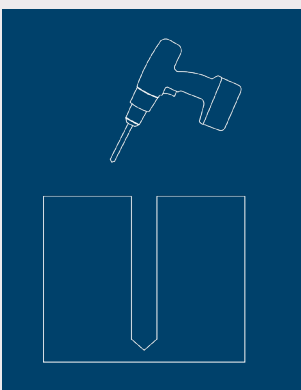

Using a 9/16th diameter bit, drill a hole into the base material to a depth at least 1/2" deeper than the required 4".

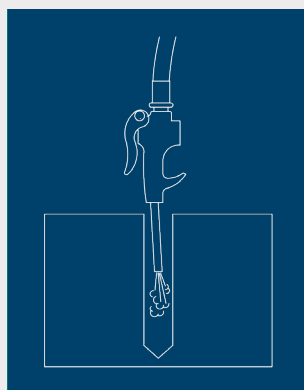

Blow the hole clean of dust and other material. Do not expand the anchor prior to installation.

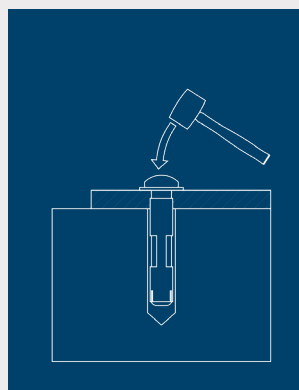

Drive the anchor through the mounting flange into the hole until the head is firmly seated. Use a rubber mallet.

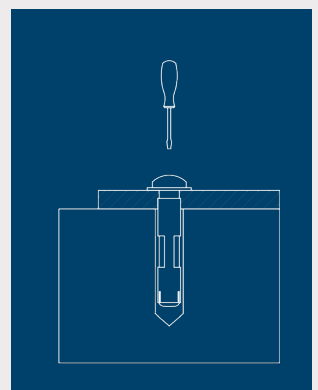

Tighten the anchor by turning the head 3 to 5 turns past finger tight or by applying the guide installation torque from the finger tight position.

The Moonrise SiteRack is able to be ordered with provisions for either surface or embed mounting. Please specify your mounting type at the time of order. All site preparations, including exterior, burial grade 1/2" electrical conduit, stubbed up 4-6" at each location. Coordination with the qualified installing electrician is imperative throughout the install process. The light, associated components, remote enclosure, power supply, instructions, mounting fasteners and security bit will be shipped with the SiteRack in a separate box.

- Embed mount units are provided with 6" extensions beyond ground level for setting into concrete or grout.
- Once the correct height is established, position the ends plumb and level as required.
- Fill the hole with Rockite® or Kwixset® Anchor Cement.

EMBED MOUNTING INSTRUCTIONS

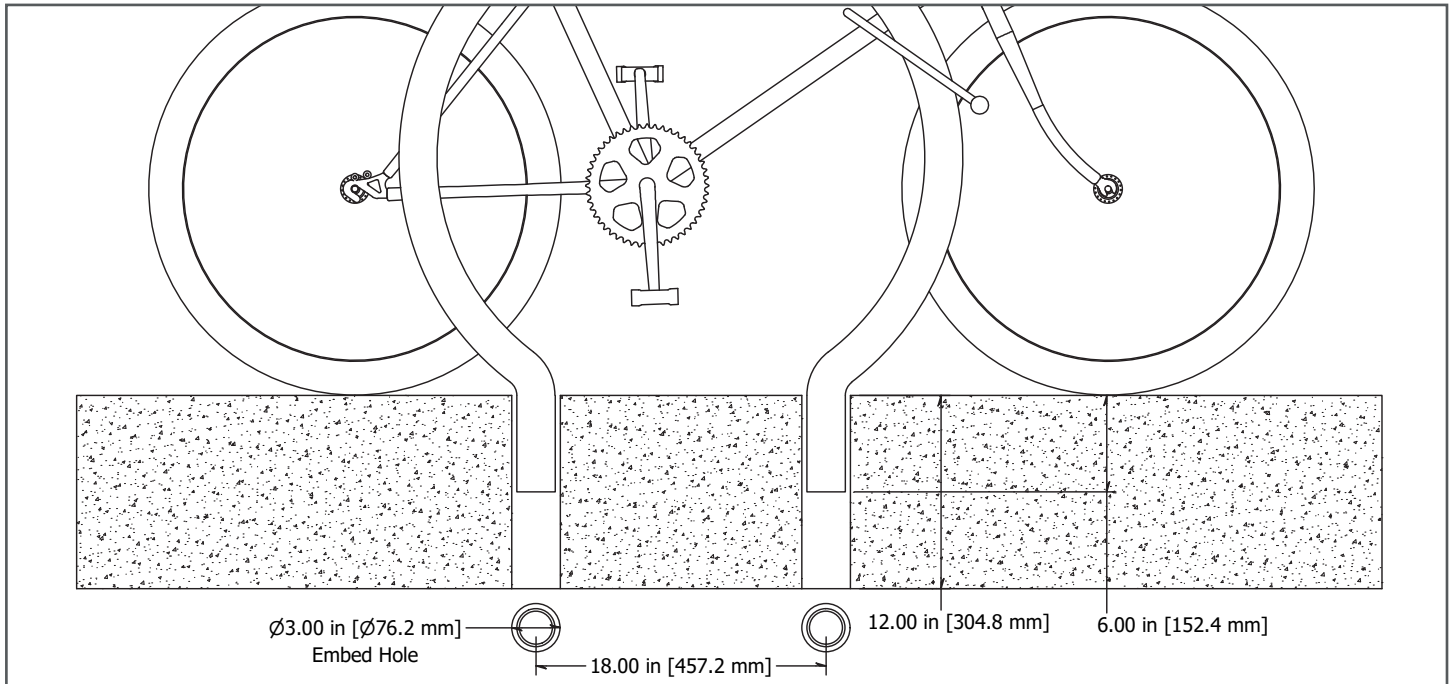

EMBED MOUNT

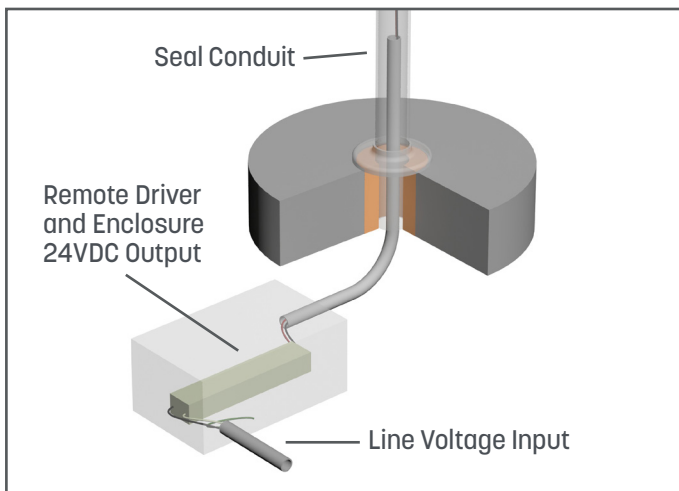

SURFACE MOUNT

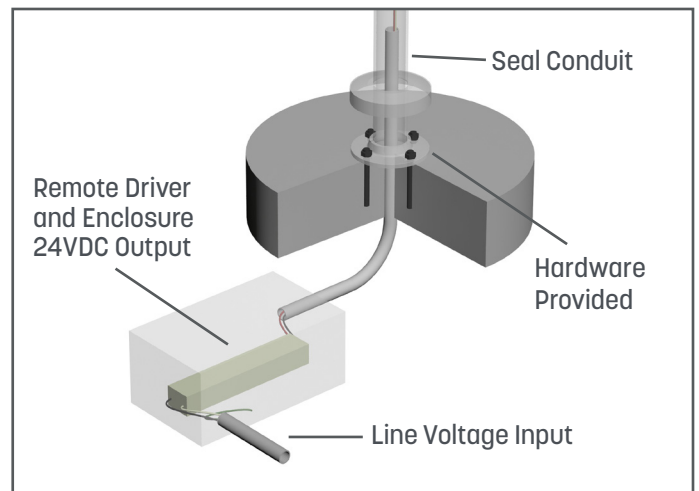

SITE LAYOUT

